

# ***INSTRUCTION MANUAL***

***Oil-in-Water Monitor***

***Type OMD-12***

**DECKMA HAMBURG GmbH**

Kieler Straße 316, D-22525 Hamburg  
Tel.: ++49 40 54 88 76-0, Fax: ++49 40 54 88 76-10, eMail: [post@deckma.com](mailto:post@deckma.com)

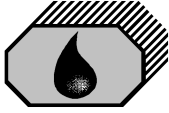

## ***IMPORTANT NOTICE***

### **Replacement components for units of the OMD series**

#### **General**

All monitors in our range are inspected and tested to strong quality requirements at our factories prior to delivery.

In normal use the units should operate correctly and without fault over a long period of time requiring only small amounts of maintenance to be carried out as outlined in the instruction manuals.

#### **Service Exchange Units**

In the event of a monitor malfunction due to electrical or electronic component failure it is our recommendation that a service exchange unit be ordered.

The defective instrument should be returned to our works within 30 days of supplying the service exchange unit, then only the repair charge is payable. Otherwise the whole cost of a service exchange unit becomes payable.

This procedure is by far the easiest and most cost effective way of ensuring the monitor on site conforms to the specifications.

#### **Component Replacement/Repair**

When replacing or repairing electronic components (except fuses) please note that due to varying component performance characteristics it may be necessary to re-adjust or calibrate the monitor.

Failure to carry out the correct procedure could result in the monitor over or under reading which in turn could lead to oil pollution and the consequences that follow.

In order to avoid this potential problem we can only advise that a service exchange unit be supplied.

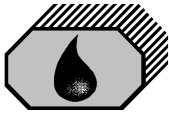

## CONTENTS

SECTION	TITLE	PAGE
1.0	Introduction	4
2.0	Important Notes	4
3.0	Principle of Operation	4
3.1	Measuring Principle	4
3.2	Features	5
3.3	Adjustment	5
3.4	Displays and Alarms	5
4.0	Specification	6
5.0	Construction	7
6.0	Installation	8
7.0	Piping	9
8.0	Wiring	10
9.0	Power Supply	11
10.0	Commissioning	12
10.1	Electrical	12
10.2	Piping	12
10.3	Functional Tests	12
10.4	Alarm Set Points and Alarm Delay	13
11.0	Operating Instructions	14
11.1	Operator Notes	14
12.0	Operator Maintenance	14
12.1	Manual Cell Clean Unit	15
13.0	Fault Finding	16
13.1	Sample Tube Replacement	17
13.2	PCB Replacement	17
13.3	Calibration	18
14.0	Spare Parts	18
14.1	Recommended On Site Spares	19
15.0	Remarks	19

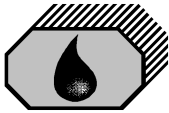

## 1.0 INTRODUCTION

The OMD-12 Bilge Alarm Unit has been designed specifically for use in conjunction with oil coolers or cooling water. At the further development of the OMD series special care has been taken for the higher water temperature. Also the range has been modified according to the expected oil concentrations.

The instrument is built according the IMO Resolution MEPC. 60(33).

The unit is supplied with 2 works-adjusted alarms at 10 ppm. Other set points (15 ppm or 20 ppm) are possible and can be adjusted on site at any time by using the buttons at the front panel. If an alarm set point is exceed, the alarms are visible at the front panel and the appropriate relays are switched.

Furthermore a 0(4) - 20 mA (equal to 0 - 30 ppm) signal output is available for driving a recorder or external meter. The connection is done with an optional available adapter.

## 2.0 IMPORTANT NOTES

- a) This equipment must be installed and operated in strict accordance with the instructions contained in this manual. Failure to do so will impair the protection provided.
- b) Installation and servicing must be undertaken by a competent and suitable skilled person.
- c) The equipment must be connected to the ground according relevant requirements.
- d) The unit must be isolated from the electrical supply before any maintenance of the equipment is attempted.
- e) All National or local codes of practice or regulations must be observed and, where applicable, are deemed to take precedence over any directive or information contained in this manual.
- f) In case of freezing conditions the measuring cell should be emptied complete.

## 3.0 PRINCIPLE OF OPERATION

### 3.1 Measuring Principle

Several optical sensors measures a combination of light scattered and absorbed by oil droplets in the sample stream. The sensor signals are then processed by a microprocessor to produce linearised output.

If an alarm (works set point 10 ppm) occurs, the two oil alarm relays are activated after the adjusted time delay.

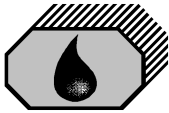

The microprocessor continuously monitors the condition of the sensor components and associated electronics to ensure that calibration accuracy is maintained over time and extremes of environmental conditions.

## 3.2 Features

- Compact and robust construction
- Low maintenance
- Small dimensions
- Low weight
- Easy installation
- Constant readiness
- Low spare part stock holding
- Watertight Housing
- Works adjustment
- Easy zero adjustment via push buttons ( $\pm 5$  ppm)

## 3.3 Adjustment

The unit is delivered with a works adjustment according the Specifications. The alarm points are set to 10 ppm.

The "Zero" point is also works adjusted and can be re-adjusted on site by using clean water and the push buttons at the front panel.

## 3.4 Displays and Alarms

In the unit are two independent alarm circuits available. Both can be set separately set from 1 to 30 ppm. From the manufacturing both alarms are set to 10 ppm. The set points can be changed according to the requirements on site, for example to 15 ppm or 20 ppm. An alarm point setting above 30 ppm is not possible. The adjustment can be done in the programming mode as described in Section 10.4.

In this mode also the individual adjustment of the time delays for the alarms and the possible changing between 0 - 20 mA or 4 - 20 mA output can be done.

Both alarm circuits are also connected with an alarm LED on the front panel.

Additional to the alarm LED's each alarm circuit is equipped with a relay with potential free alarm contacts. These contacts can be used for external processing of the signal or for control of further functions.

If a malfunction or failure of the power supply occurs, both relays will switch to alarm condition.

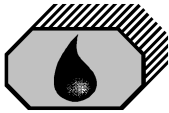

## 4.0 SPECIFICATION

Range:	0 - 30 ppm, Trend up to 50 ppm
Accuracy	Better than $\pm 5$ ppm
Linearity	Better than $\pm 2$ %
Display	2 digits 14 segment LED's
Power Supply:	24 Volt AC/DC $\pm 15\%$
Consumption:	5 VA
Alarm Points:	Adjustable between 1 - 30 ppm (Works adjustment 10 ppm)
Alarm Operating Delay:	Adjustable between 2 - 30 sec. (Works adjustment 1 = 2 sec, 2 = 10 sec)
System Fault Alarm:	LED
Alarm Contact Rating:	Potential free 1 pole change over contacts, 3 A / 24 V
Alarm Indication:	Red LED's
Output Signal:	0 - 20 mA or 4 - 20 mA, reversible $R_i < 500 \Omega$
Sample Water Pressure:	0,1 - 8 bar
Sample Flow:	approx. 0,5 - 4 l/min depend. to pressure
Ambient Temperature:	- 20 to + 70° C
Sample Water Temperature:	+ 1 to + 70° C
Roll:	up to 22,5°
Size (over all):	175 mm W x 190 mm H x 220 mm D
Degree of Protection:	IP 65
Weight:	3,5 kg
Pipe Connections:	R 1/4" Female

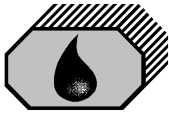

## 5.0 CONSTRUCTION

All components are assembled in an alloy enclosure with the protection class IP 65. The optical components are mounted directly on the printed circuit board. The plug in technology assures an easy changing of the components together with an compact and robust construction. The electronic is designed to the latest state of art.

The wetted parts are produced out of Stainless Steel to assure a reliable corrosion protection for a long time. The sample water is fed to the unit from underneath and is discharged above to the side.

The mounting brackets of the unit are prepared at the rear of the unit either for wall or bulkhead mounting.

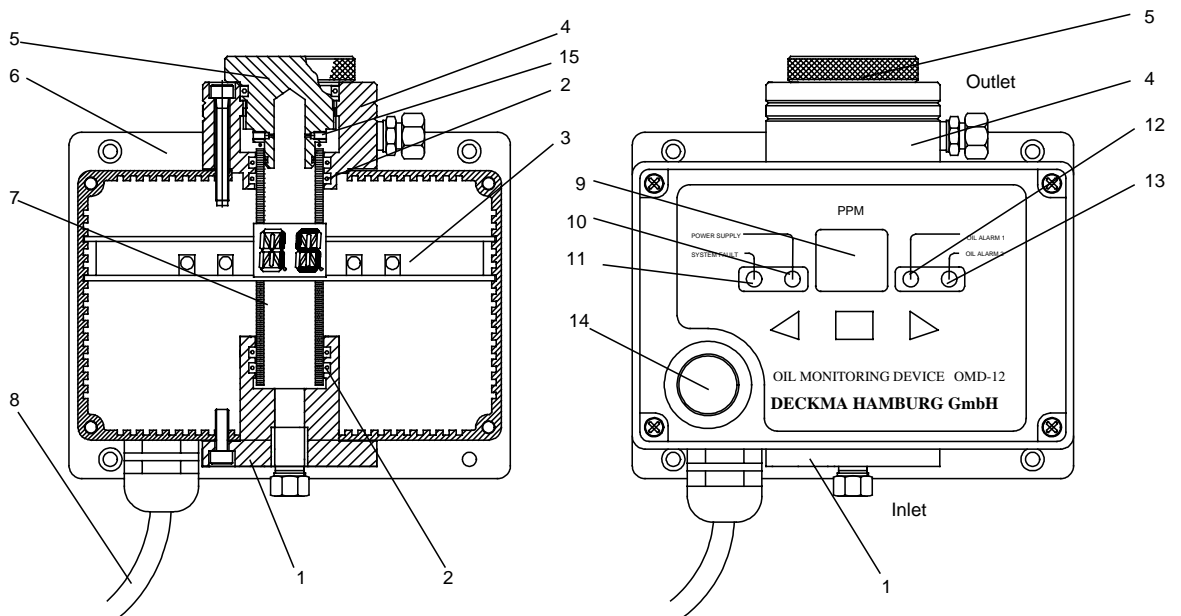

1	Inlet block	6	Housing	11	LED "Fault"
2	O-Rings	7	Sample cell tube	12	LED "Alarm 1"
3	Printed Circuit Board	8	Connection cable	13	LED "Alarm 2"
4	Outlet block	9	Display	14	Desiccator
5	Head screw	10	LED "Power"	15	Flow adjustm. screws

Fig. 1

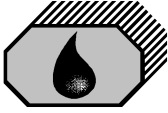

## 6.0 INSTALLATION (Refer to Fig. 2 and Fig. 3)

See Section 2 for important notes concerning installation.

The OMD-12 Monitor should be located as close as possible to the oily water separator to minimise response delays. Under no circumstances should the distance between the monitor and the separator exceed 8 meters since this would result in a response time of more than 20 seconds and breach IMO regulations.

Mount the OMD-12 Monitor by means of 4 x M5 screws on to a rigid vertical surface and preferably with the display panel of the monitor at eye level. For service and maintenance sufficient space to all sides should be available.

Care must be taken at mounting of the pipes connections to avoid any torsion of the housing and damage of the instrument.

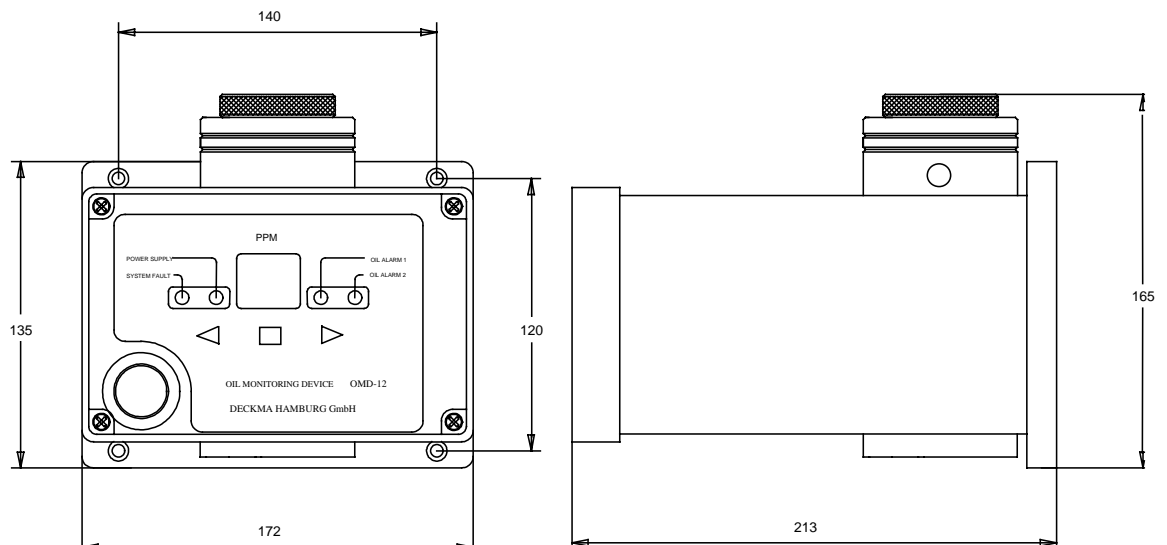
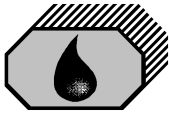

Fig. 2





## 7.0 PIPING (Refer to Fig. 3)

Connect the OMD-12 Monitor to the sample point of the oily-water separator outlet and to a source of oil free water employing 10 mm OD copper or stainless steel pipe. The sample point should be located on a vertical section of the separator outflow piping to minimise the effects of any entrained air. The tapping point should be at a level above the outlet of the monitor to ensure the sample all is flooded at all times.

If connection to a vertical section of the separator outlet piping is impractical, the tapping may be made into the side of the horizontal pipe. Avoid top or bottom entry.

For separator discharge pipes up to 75 mm OD a standard "T"-type junction of the welded or screwed type is satisfactory for the tapping point. For the separator discharge pipes of 80 mm OD and above a sample probe should be employed which protrudes into the discharge piping by approx. 25 % of the ID of the pipe.



Abb. 3



## 8.0 WIRING (Refer to Fig. 4)

*See Section 2 for important notes concerning wiring.*

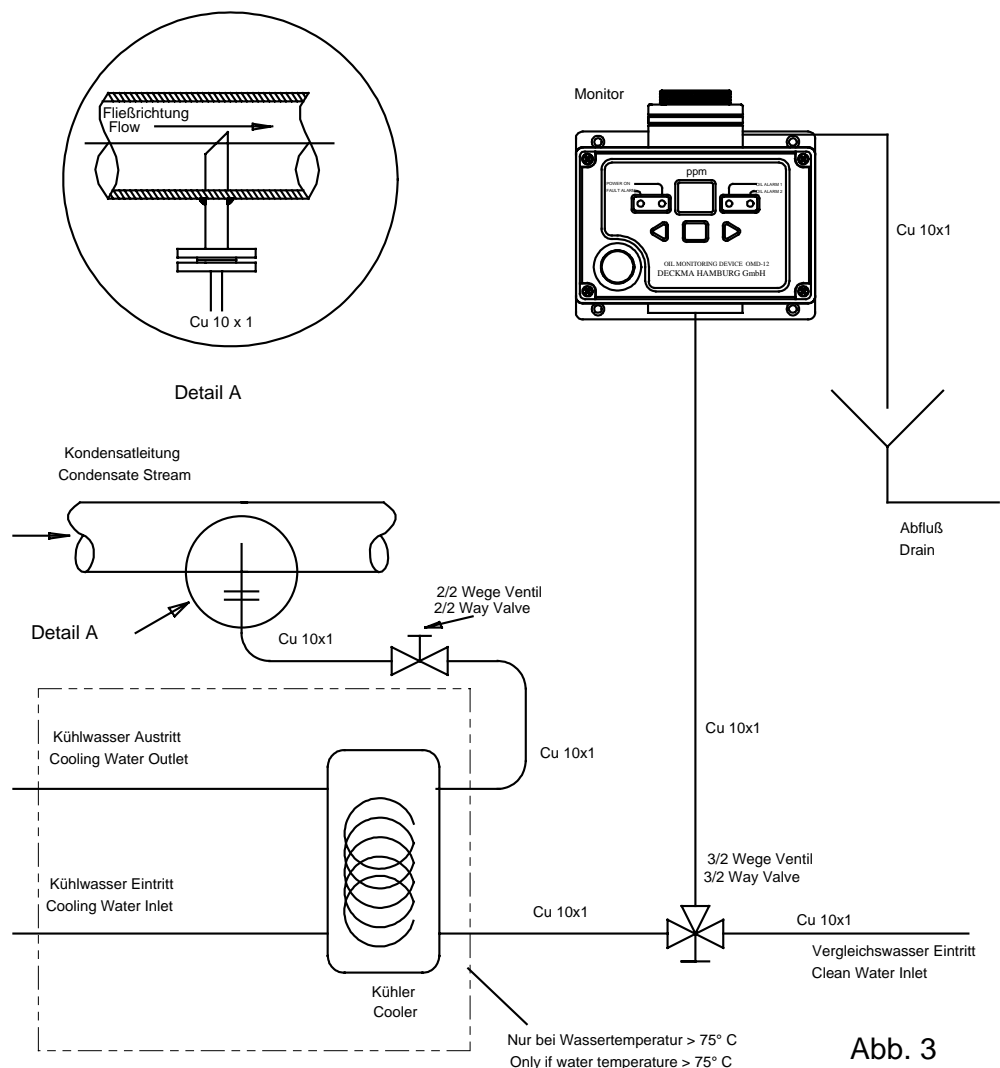
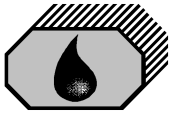
This unit must be connected to the mains supply via a suitable rated and approved fused isolator unless such fusing / isolation is provided by associated equipment. When fitted, the isolator should be close, readily accessible and marked as to function.

The OMD-12 Monitor is normally delivered with a 9 pole, 2 m length connection cable. Details are shown in Fig. 4, Page 11. The monitor can be connected direct to the control box of the oily-water separator. For special requirements junction boxes are available.

If only a power supply of 115 to 230 VAC is available, a suitable power supply unit is required. These units are optional available on order.

Precise wiring details will vary dependent upon the control system to be employed but the most frequently used systems employ alarm relay 1 for alarm only and alarm relay 2 for control purposes. This system is shown in Drwg. No. 60600-50.

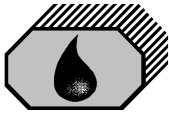

## 9.0 POWER SUPPLY

See Section 2 for important notes.

The unit is designed for a power supply of 24 VAC or 24 VDC  $\pm 15\%$ . For a power supply of 110 VAC up to 230 VAC special power supply units have been developed. These units are optional available on request.

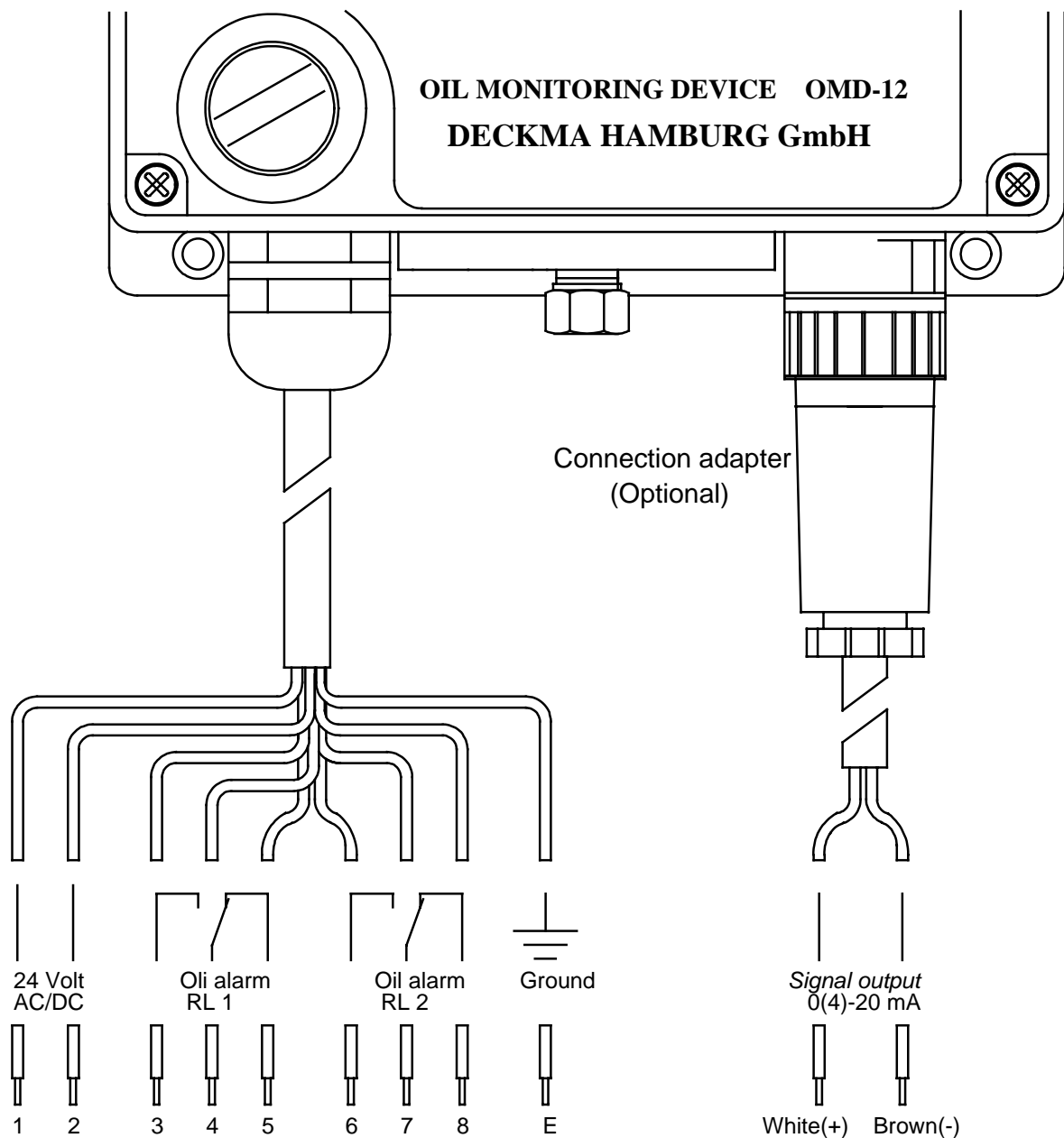
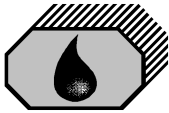

Fig. 4



## 10.0 COMMISSIONING

See Section 2 for important notes.

On completion of the installation, wiring and piping carry out the following checks:

### 10.1 Electrical

- a) Check that the power supply of 24 V is connected to the cores 1 + 2 of the connection cable.
- b) Check that the earthing has been made according to the relevant regulations.

### 10.2 Piping

- a) Check all piping connections for leaks and rectify as appropriate.

### 10.3 Functional Tests

- a) Run oil free water through the instrument to purge the system.
- b) Adjust the flow rate through the unit by using the small screws in the cell cap (Fig. 1, Pos. 15). Taking out a screw will increase the flow rate.

**NB:**The flow rate should be checked on both, the clean water supply and the separator sample supply. If the clean water supply is obtained from a high pressure source, the flow rate will be higher than from the sample point.

The flow rate is not influencing the accuracy of the instrument. The adjustment is only important for the time delay between the sample point and the monitor.

- c) Switch on the instrument and make sure, that the Power LED is illuminated and the display is changing between "INI" and numbers, decreasing from "20". The monitor will display "0" with clean water, otherwise the monitor will be in working conditions when it reached the measured value. Allow a few minutes for the system to warm up and stabilise.

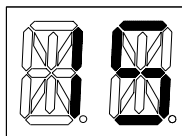
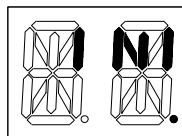

- d) During oil free water is running through the monitor check the Zero adjustment according Section 11. The display should be "0". If the display varies by greater amounts, it may be that air entrainment is present. If this is the case, the cause must be located and rectified.

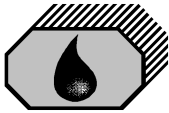

- e) If the Zero need to be calibrated, this can be done by using the buttons at the front panel. Pressing simultaneously the buttons " ← " and " □ " will decrease the display, pressing simultaneously the buttons " □ " and " ⇒ " will result in a higher reading.

## 10.4 Alarm Set Points and Time Delay

Both alarm relays can be set to an individually threshold between 1 - 30 ppm and a time delay between 2 - 30 sec. if required. The works adjustment for both thresholds is 10 ppm. The time delay for alarm relay 1 is works adjusted to 2 sec. and for alarm relay 2 to 10 sec. All adjustments can be changed on site by using the buttons at the front panel.

The adjustment can only be done in the programming mode. To enter this mode, all 3 buttons " ← □ ⇒ " have to be pressed simultaneously when the monitor is powered on. During the programming mode the unit is in alarm conditions.

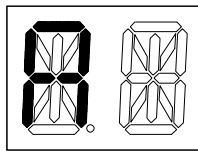

After starting the programming mode the display will show an "A" changing with the actual alarm set point. At the same time the alarm LED for alarm circuit 1 is energised. Pressing the " ← " button will decrease the set point, pressing the " ⇒ " button will increase the threshold. An alarm set point above 30 ppm is not possible.

When the changed set point is confirmed by pressing the " □ " button, or if the internal adjusted time without pressing any button is passed, the display will show a "T" changing with the actual time delay. At the same time the alarm LED for alarm circuit 1 is energised. Pressing the " ← " button will decrease the time delay pressing the " ⇒ " button will increase the time delay. A time delay above 30 sec. is not possible.

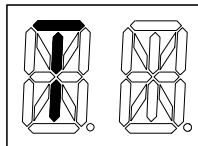

After confirming the selected value the sequence is repeated for alarm circuit 2. In this case the alarm LED for alarm circuit 2 is energised.

The last point of the programming mode is done by the choice for the signal output. It can be changed between 0 - 20 mA and 4 - 20 mA.

The changing is done similar to the a.m. settings by using the " ← " or the " ⇒ " button. The display will show the actual value of "0-" or "4-".

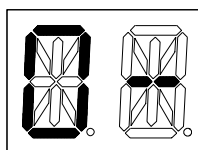
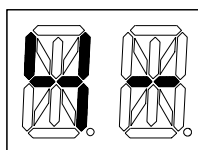

NB:

All changed values have to be confirmed by pressing the " □ " button. Otherwise the existing values are valid.

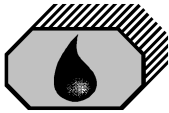

## 11.0 OPERATING INSTRUCTIONS

- a) Switch on the power supply.
- b) Allow 2 minutes for the instrument to warm up.
- c) Flow oil free water through the system for a few minutes and check that the display show "0". If not, calibrate the display by using the buttons at the front panel. Pressing simultaneously the buttons " ← " and " □ " will decrease the value, pressing simultaneously the buttons " □ " and " ⇒ " will result in a higher reading.
- d) Switch the instrument sample supply from the clean water supply to the sampling point connection.
- e) The instrument is now ready for use.

### 11.1 Operator Notes

- a) When oily water flows through the instrument the display will show the actual value of oil content.
- b) If the oil concentration exceeds the adjusted threshold (works adjustment 10 ppm), the alarm indicator 1 will be illuminated and the associated alarm relay will operate within the adjusted time delay. Accordingly also the alarm indicator 2 will be illuminated and its associated alarm relay will take the appropriate shut down action.

## 12.0 OPERATOR MAINTENANCE

*See Section 2 for important notes.*

AT WEEKLY INTERVALS:

- a) Check the Zero adjustment with oil free water flowing through the instrument. Refer to Section 11.
- b) Flush the cell with oil free water.
- c) Isolate the instrument from both, sample and oil free water supply.
- d) Unscrew and remove the cell cap.
- e) Insert a suitable bottle brush (Art. No. 30102) into the cell and clean it with upwards and downwards motion through the entire length of the cell several times.
- f) Remove the bottle brush and replace the cell cap.
- g) Reconnect the oil free water supply and allow this to flow through the instrument for a few minutes.
- h) Observe that the display is showing "0". If not, refer to Section 11.

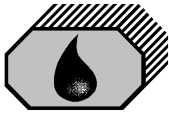

- i) Examine the colour of the desiccator (Fig. 1, Pos. 14). Blue colour is indicating an active moisture absorber. If the colour is light blue or white, the desiccator should be replaced.

The desiccator assures a low humidity inside the measuring cell to avoid wrong measurement resulting from condensation at the cell glass tube. The replacement is easily done without opening the instrument. Just unscrew the old desiccator out of the front panel and replace it by a new one. The protection cap of the spare unit can be also used as a tool.

- j) Reconnect the instrument to the separator sampling point.

## 12.1 Manual Cell Clean Unit

*Optional item if fitted*

This unit facilitates cleaning of the cell without the need of removing the cell cap. Regular use of this device should prevent malfunction of the monitor due simply to fouling of the sample tube and all the inconvenience which this can cause.

### Operating Instructions

- a) Ensure that the monitor is switched off and that there is a clean water supply through the cell.
- b) Activate the manual cell clean unit by pressing the handle several times.
- c) Switch the monitor back on and check the zero according Section 11.
- d) Repeat a) to c) at least once a week or as necessary.

**NB:** The Manual Cell Clean Unit may also be used during normal operation with sample water, but in this case an alarm occurs because the wiper is passing the light source.

Spares: Wiper Seal, Art. No. 30605

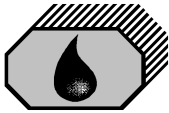

## 13.0 FAULT FINDING

See Section 2 for important notes.

A fault is indicated, when the green "Power"-LED is off and the red "Fault"-LED is illuminated. Simultaneously a fault code will be shown at the display:

Display	Reason	Servicing
	Meter out of range (only when without flashing) Oil content too high, dirty sample tube	Clean sample tube, wait until oil content is within the range
	Fault indication flashing in connection with "TR" or "SF"	See under "TR" or "SF"
	System Fault, damaged LED or faulty electronics	Changing of PCB, repair at manufacturer
	Transmission Fault, sample too dark, sample tube dirty	Cleaning of sample tube
	Water failure, water inside the housing of the unit	Open the unit, clean and dry the housing, replacement of sample tube as necessary Calibration according Section 13.3.
	Calibration request after changing the position of Jumper J1 inside the instrument	Calibration according Section 13.3
All other displays	System Fault	Changing of PCB, repair at manufacturer



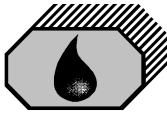

## 13.1 Sample Cell Tube Replacement ( Refer to Fig. 1)

- a) Switch off the Power supply.
- b) Remove all piping from the instrument.
- c) Open the instrument and remove the front panel. Disconnect the plug connection from the PCB (Drwg. No. 60600-50, P4). Pull the PCB carefully out of its seat.
- d) Loosen the 3 screws from the outlet block (4) and remove this carefully. Loosen the 3 screws from the inlet block (1) and remove this together with the sample tube (7).
- e) Clean the inner part of the instrument and make sure, that everything is dry.
- f) Replace the O-Rings (2) and the sample tube (7) in the inlet block (1). Replace the O-Rings (2) in the outlet block (4).
- g) Mount the inlet block, the outlet block and the piping.
- h) Do a pressure test of appr. 8 bar with oil free water and make sure, that the sample tube is absolutely clean from outside.
- i) Mount the PCB and make sure, that the connection wirings are placed in the associated spaces. Reconnect the front panel with the PCB (Drwg. No. 60600-30) and mount it.
- j) Examine the colour of the desiccator (Fig. 1, Pos. 14). If the colour is light blue or white, the desiccator need to be replaced.
- k) Carry out a calibration according Section 13.3.

## 13.2 PCB Replacement (Refer to Fig. 1)

- a) Switch off the power supply and stop the water flow.
- b) Open the instrument and remove the front panel. Disconnect the plug connection to the PCB.
- c) Pull the PCB carefully out of its seat and disconnect the wiring.
- d) Connect the new PCB accordingly.
- e) Mount the PCB and the front panel (See 13.1 i).
- f) Examine the colour of the desiccator (14). If the colour is light blue or white, the desiccator need to be replaced.
- g) Carry out a calibration according Section 13.3.

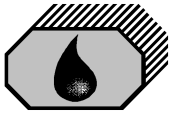

## 13.3 Calibration ( Drwg. No. 60600-30)

For a calibration on site it is necessary, to have a definite fluid for comparison available. With the OMD-12 Monitor a formazin in water solution with the concentration of 100 FTU (Formazin Turbidity Units) has to be used. A suitable calibration set can be ordered separately under Art. No. 18500.

- a) Switch off the power supply and stop any water flow.
- b) Open the instrument and remove the front panel. Pull the PCB carefully until the jumper J1 is reachable.
- c) Put the jumper J1 to its opposite position, so that the other 2 pins than before are linked.
- d) Mount the front panel and switch on the power supply. The display will show "CA" and the instrument is in alarm condition.
- e) Clean the sample tube accurate by using a suitable bottle brush as described under Section 12.
- f) Empty the sample tube and fill it with a solution of 100 FTU as described with the calibration set. It may be necessary, to fill the sample tube twice with the formazin solution to avoid any dilution with a rest of the oil free water from cleaning.
- g) If it is sure, that the correct formazin solution is in the instrument, press the buttons " ⇐ " and " ⇒ " simultaneously. The display will show  $16 \pm 1$  and the instrument is calibrated.
- h) Continue as described under Section 11.

## 14.0 SPARE PARTS

When ordering spares, it is important to supply details of the type of monitor, part number of each spare required, its description and any relevant serial number.

DESCRIPTION	ART-NUMBER
Sample Cell Tube	50540
Fuse, 250 mA T, F1	40102
O-Ring Set	60545
Desiccator	50550
Printed Circuit Board	60612

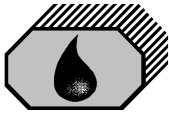

## 14.1 Recommended On Board Spares

2 off Desiccator	50550
1 off Sample Cell Tube	50540
2 off Fuse	40102
1 off O-Ring Set	60545
Optional item	
1 off Manual Cell Clean Unit	60580

## 15.0 REMARKS

All the modifications and deviations from the standard form, which have to be carried out in the supply, should be attached at this paragraph.

Commissioned on: .....

Date

by: .....

Firm's Name

Remarks:

---

---

---

---

---

---

---

---

- Brücke 2/3                    230 Volt Eingang
- Brücke 1/3 und 2/4        110 Volt Eingang
- Link 2/3                        230 Volt Input
- Link 1/3 and 2/4            110 Volt Input

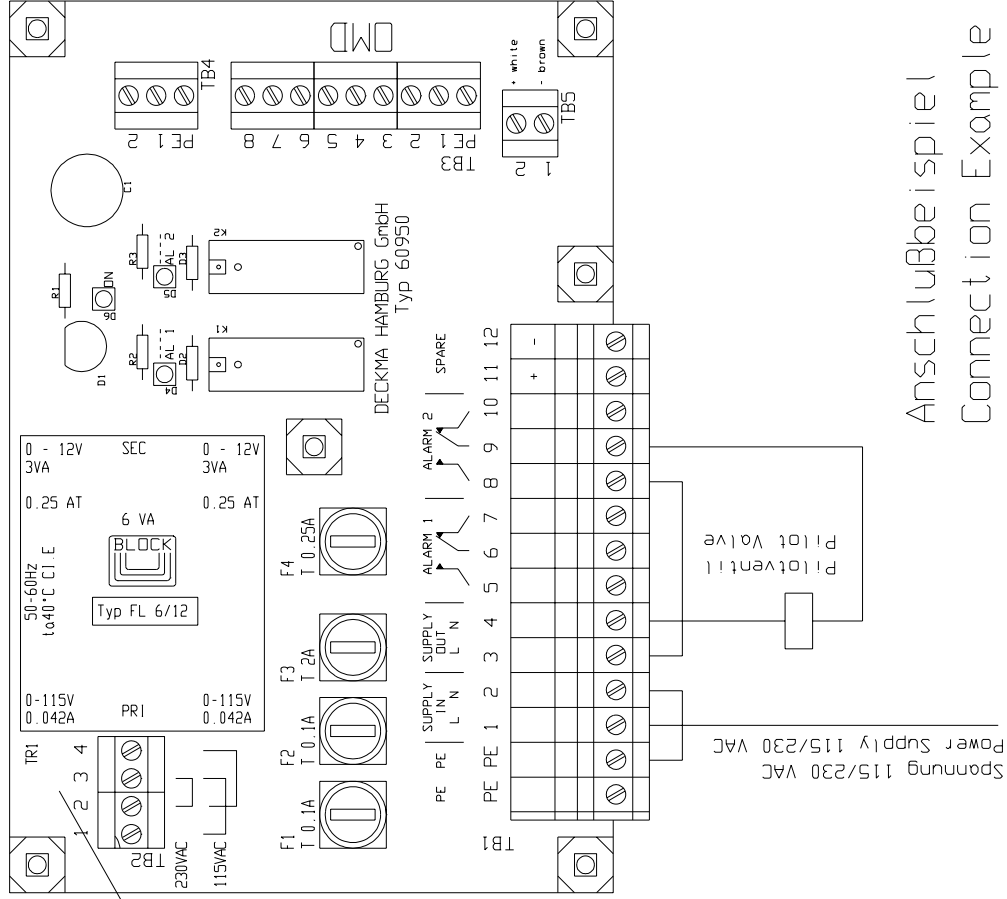

Anschluss OMD-Monitors

## Anschlussbeispiel Connection Example

<b>DECKMA</b> HAMBURG	Rev	Datum	Bearbeiter	Netzteileplatte 01 in Wasser Monitor OMD Power PCB OMD-Monitors		Bau	Bl.	von	Ab	logge
	0	28.12.97	Rathien			X	1	1	1	
	1	08.12.98	Rathien			Job	Z.	-Nr.	60950_60	
	2	28.06.01	Rathien			X				

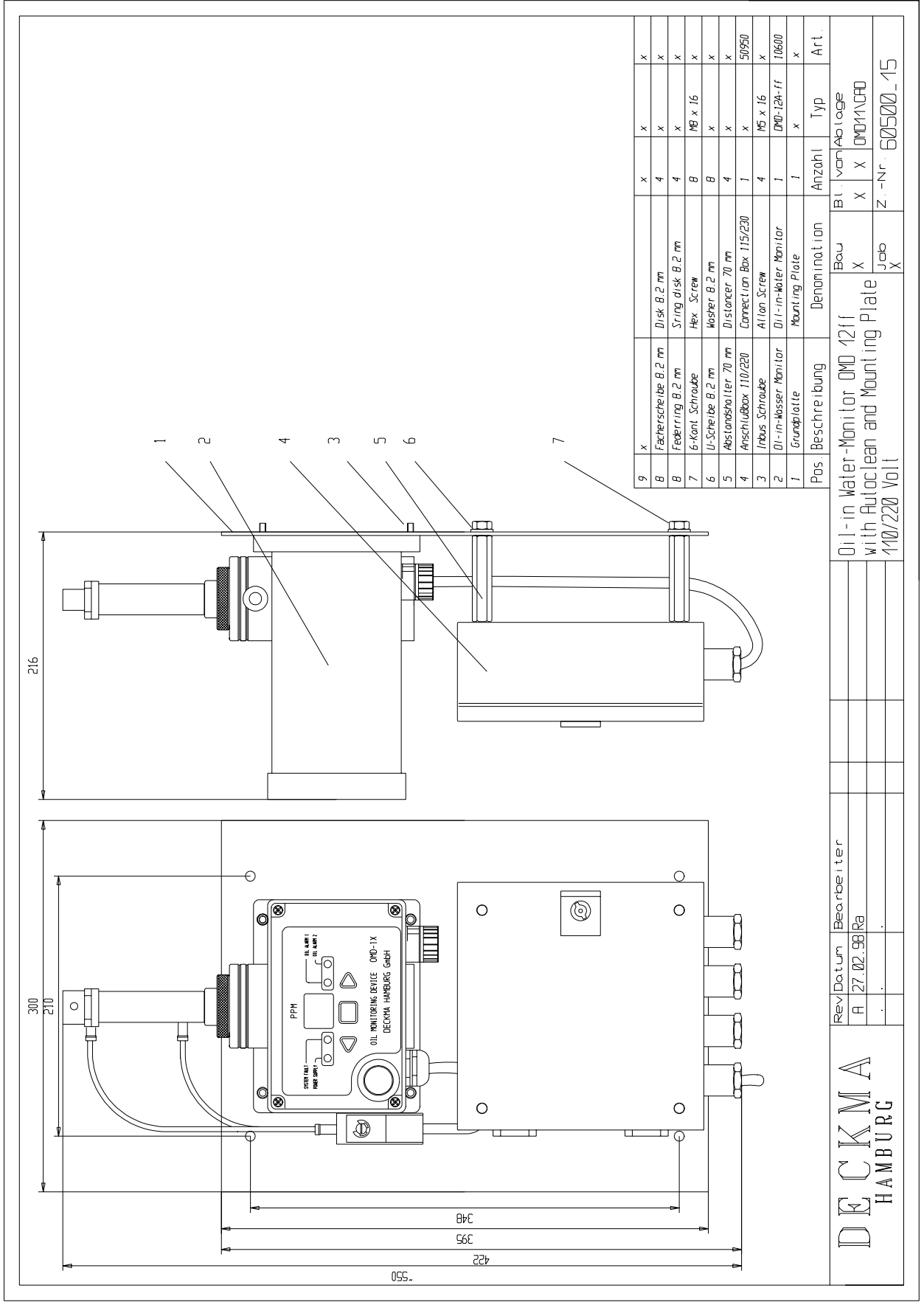

Pos.	Beschreibung	Denomination	Anzahl	Typ	Art.
9	x		x	x	x
8	Facherschleibe 8,2 mm	Disk 8,2 mm	4	x	x
8	Federring 6,2 mm	Spring disk 8,2 mm	4	x	x
7	6-Kant Schraube	Hex. Screw	8	M8 x 16	x
6	U-Scheibe 6,2 mm	Washer 6,2 mm	8	x	x
5	Abstandshalter 70 mm	Distancer 70 mm	4	x	x
4	Anschlußbox 110/220	Connection Box 115/230	1	x	50950
3	Inbus Schraube	Allion Screw	4	M5 x 16	x
2	Oil-in-Wasser-Monitor	Oil-in-Water Monitor	1	OMD-12A-1f	10600
1	Grundplatte	Mounting Plate	1	x	x

Rev	Datum	Bearbeiter	
A	27.02.98	Ra	
Oil-in-Water-Monitor OMD 1211 with Autoclean and Mounting Plate 110/220 Volt			
Bau		Bl. / von	
X		X	
Job		OMD1A/CFO	
X		Z -Nr 60500-15	

**DECKMA**  
HAMBURG